

MITSUBISHI Pch POWER MOSFET

FY4ADJ-03A

HIGH-SPEED SWITCHING USE

FY4ADJ-03A

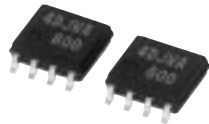

- 4V DRIVE
- V_{DSS} -30V
- $r_{DS(ON)}$ (MAX) 80m Ω
- I_D -4A

OUTLINE DRAWING

Dimensions in mm

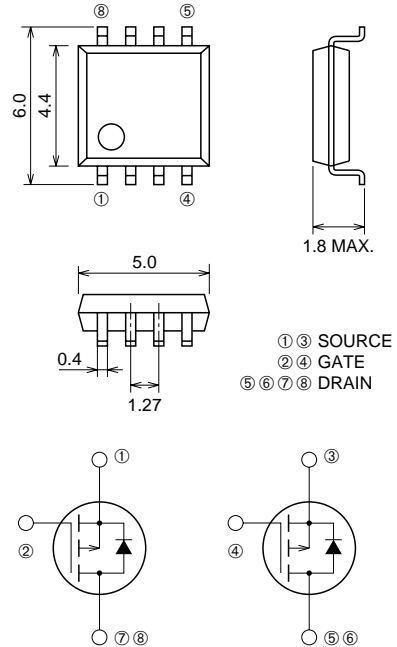

SOP-8

APPLICATION

Motor control, Lamp control, Solenoid control
DC-DC converter, etc.

MAXIMUM RATINGS (T_c = 25°C)

Symbol	Parameter	Conditions	Ratings	Unit
V_{DSS}	Drain-source voltage	$V_{GS} = 0V$	-30	V
V_{GSS}	Gate-source voltage	$V_{DS} = 0V$	± 20	V
I_D	Drain current		-4	A
I_{DM}	Drain current (Pulsed)		-28	A
I_{DA}	Avalanche drain current (Pulsed)	$L = 10\mu H$	-4	A
I_S	Source current		-1.7	A
I_{SM}	Source current (Pulsed)		-6.8	A
P_D	Maximum power dissipation		1.6	W
T_{ch}	Channel temperature		-55 ~ +150	°C
T_{stg}	Storage temperature		-55 ~ +150	°C
—	Weight	Typical value	0.07	g

Sep.1998

ELECTRICAL CHARACTERISTICS (Tch = 25°C)

Symbol	Parameter	Test conditions	Limits			Unit
			Min.	Typ.	Max.	
V (BR) DSS	Drain-source breakdown voltage	Id = -1mA, VGS = 0V	-30	—	—	V
IGSS	Gate-source leakage current	VGS = ±20V, VDS = 0V	—	—	±0.1	μA
IDSS	Drain-source leakage current	VDS = -30V, VGS = 0V	—	—	-0.1	mA
VGS (th)	Gate-source threshold voltage	Id = -1mA, VDS = 10V	-1.5	-2.0	-2.5	V
rDS (ON)	Drain-source on-state resistance	Id = -4A, VGS = -10V	—	60	80	mΩ
rDS (ON)	Drain-source on-state resistance	Id = -2A, VGS = -4V	—	115	180	mΩ
VDS (ON)	Drain-source on-state voltage	Id = -4A, VGS = -10V	—	-0.24	-0.32	V
yfs	Forward transfer admittance	Id = -4A, VDS = -10V	—	6	—	S
Ciss	Input capacitance	VDS = -10V, VGS = 0V, f = 1MHz	—	680	—	pF
Coss	Output capacitance		—	180	—	pF
Crss	Reverse transfer capacitance		—	90	—	pF
td (on)	Turn-on delay time		—	10	—	ns
tr	Rise time	VDD = -15V, Id = -2A, VGS = -10V, RGEN = RGS = 50Ω	—	15	—	ns
td (off)	Turn-off delay time		—	50	—	ns
tf	Fall time		—	30	—	ns
VSD	Source-drain voltage		IS = -1.7A, VGS = 0V	—	-0.88	-1.20
Rth (ch-a)	Thermal resistance	Channel to ambient	—	—	78.1	°C/W
trr	Reverse recovery time	IS = -1.7A, dis/dt = 50A/μs	—	70	—	ns

PERFORMANCE CURVES

POWER DISSIPATION DERATING CURVE

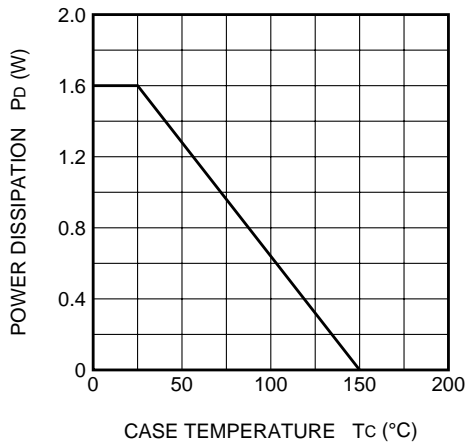

MAXIMUM SAFE OPERATING AREA

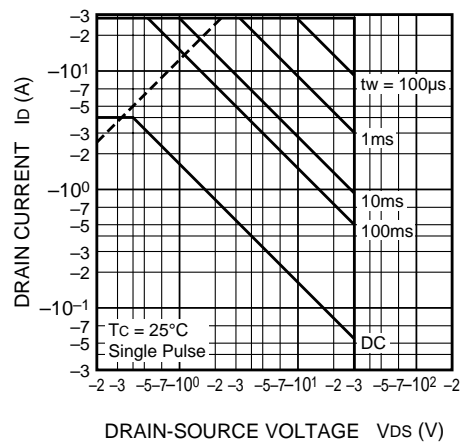

OUTPUT CHARACTERISTICS (TYPICAL)

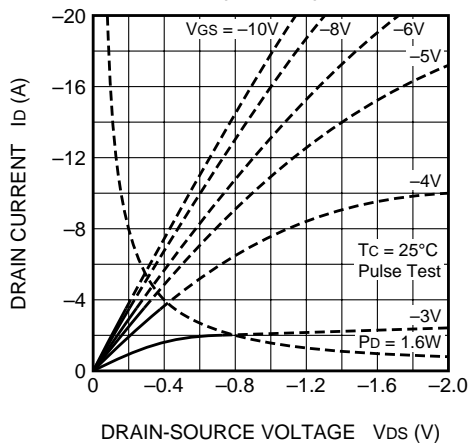

OUTPUT CHARACTERISTICS (TYPICAL)

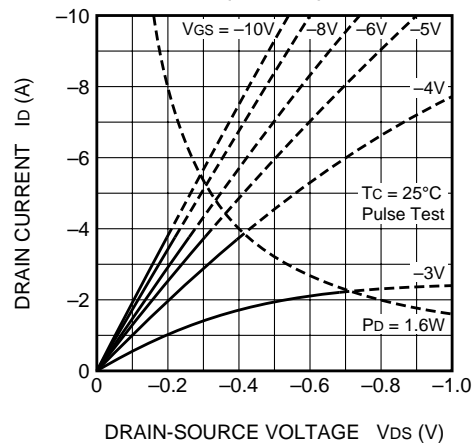

ON-STATE VOLTAGE VS. GATE-SOURCE VOLTAGE (TYPICAL)

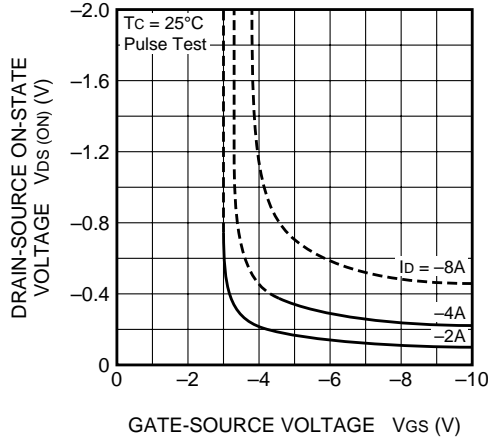

ON-STATE RESISTANCE VS. DRAIN CURRENT (TYPICAL)

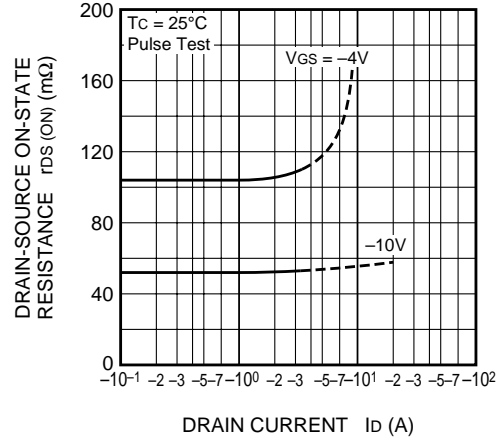

TRANSFER CHARACTERISTICS (TYPICAL)

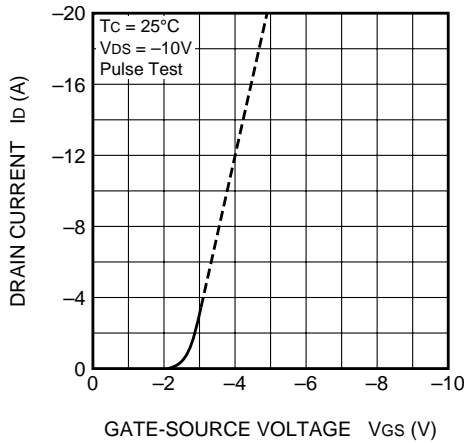

FORWARD TRANSFER ADMITTANCE VS. DRAIN CURRENT (TYPICAL)

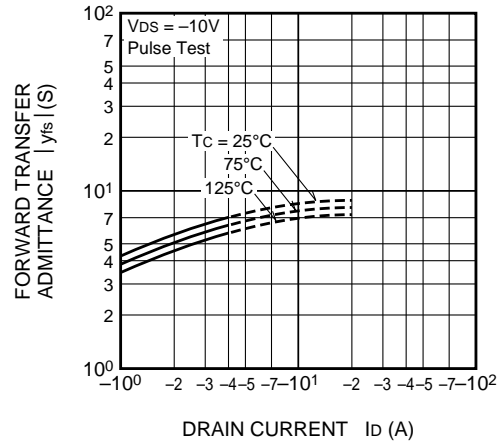

CAPACITANCE VS. DRAIN-SOURCE VOLTAGE (TYPICAL)

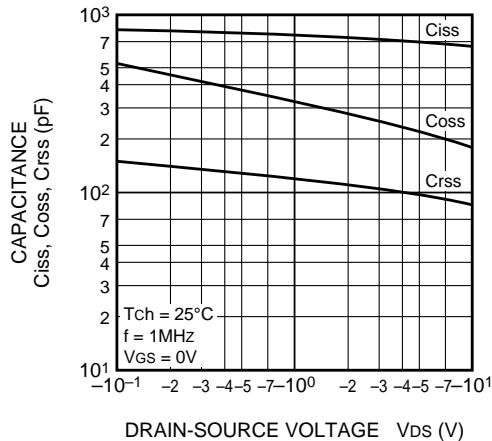

SWITCHING CHARACTERISTICS (TYPICAL)

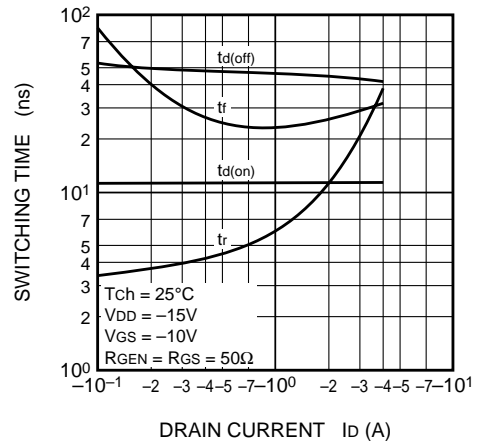

GATE-SOURCE VOLTAGE VS. GATE CHARGE (TYPICAL)

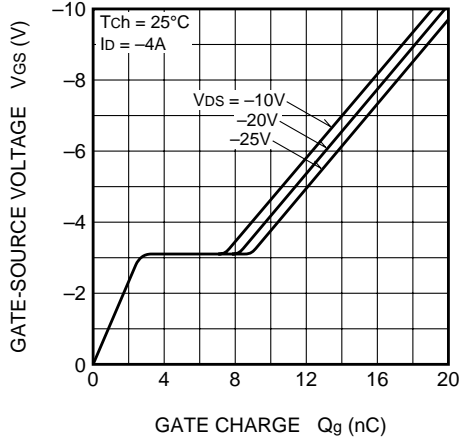

SOURCE-DRAIN DIODE FORWARD CHARACTERISTICS (TYPICAL)

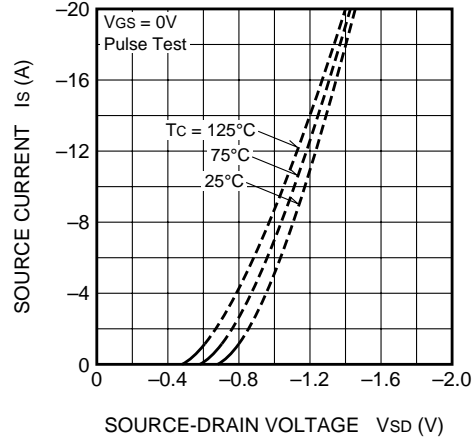

ON-STATE RESISTANCE VS. CHANNEL TEMPERATURE (TYPICAL)

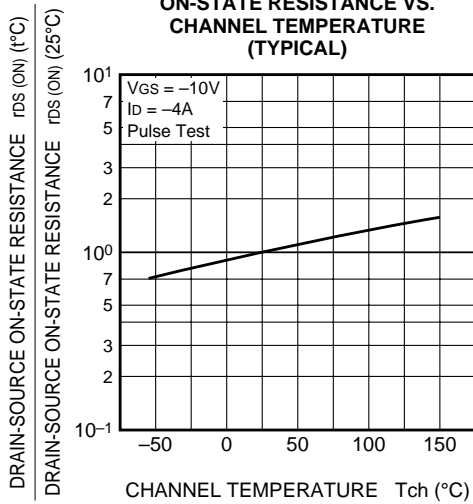

THRESHOLD VOLTAGE VS. CHANNEL TEMPERATURE (TYPICAL)

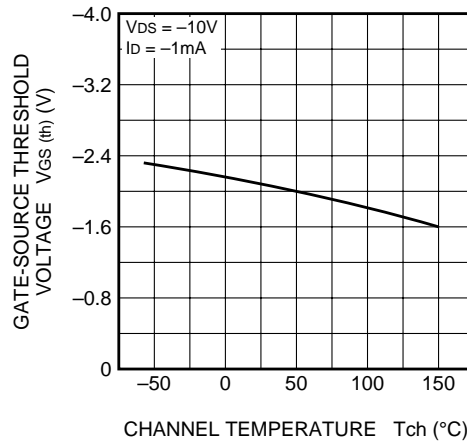

BREAKDOWN VOLTAGE VS. CHANNEL TEMPERATURE (TYPICAL)

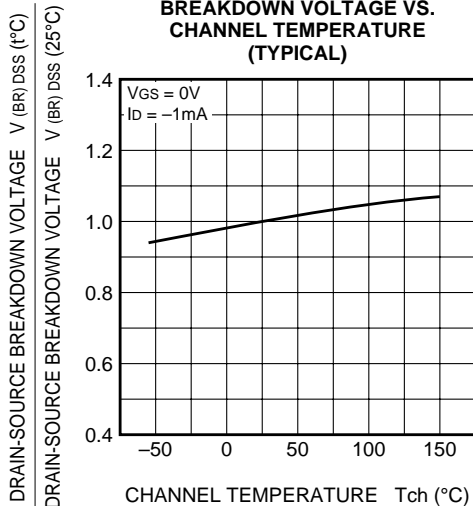

TRANSIENT THERMAL IMPEDANCE CHARACTERISTICS

